

1. Scope

This specification is applicable to Common Mode Noise Filter, used for general electronic equipment.

2. Dimensions in mm (not to scale)

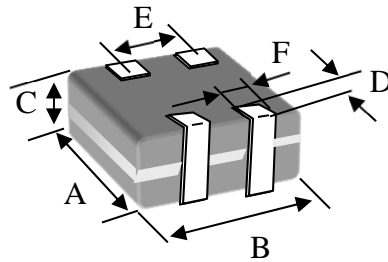

Unit: mm (inch)

A	B	C	D	E	F
0.65±0.05 (.026±.002)	0.85±0.05 (.033±.002)	0.45±0.05 (.018±.002)	0.10 min. (.004 min.)	0.50±0.1 (.020±.004)	0.27±0.1 (.011±.004)

3. Structure

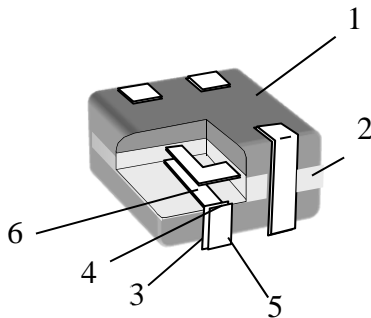

1	Ni-Zn Ferrite
2	Glass ceramic
3	Outer Termination(Ag)
4	Ni Plate
5	Sn Plate
6	Inner Conductor(Ag)

4. Schematic

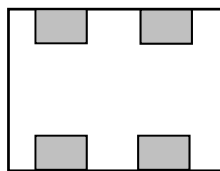

No polarity

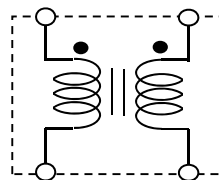

No polarity

5. Part Number

$\hat{U}$   $\hat{A}$   $\hat{C}$      $\frac{1}{2)}$      $\frac{4}{3)}$      $\frac{C}{4)}$      $\frac{H}{5)}$      $\frac{350}{6)}$      $\frac{U}{7)}$

- 1) Product Code -----  $\hat{U}$ VC: Noise Suppression Filter
- 2) External Dimensions ----- 1: 0.85mm(L) $\times$ 0.65mm(W) $\times$ 0.45mm(H)
- 3) Number of Terminations ----- 4: 4 pins
- 4) Type ----- C: Coupled Type
- 5) Characteristics ----- H: For Ultra High speed Differential Transmission
- 6) Nominal Impedance Value ----- ex) 350:  $\underline{35} \times 10^0 (\Omega)$
- 7) Packaging ----- U: Embossed Tape

6. Rating

Part No.	Common Mode Impedance <sup>*1</sup> at 100MHz	Differential Mode Impedance <sup>*2</sup> at 100MHz	Rated Voltage (V DC)	Rated Current (mA DC)	DC Resistance ( $\Omega$ .)
$\hat{U}$ VC14CH120U	12( $\Omega$ ) $\pm$ 5( $\Omega$ )	10( $\Omega$ ) max.	5	100	1.0( $\Omega$ ) max
$\hat{U}$ VC14CH350U	35( $\Omega$ ) $\pm$ 30(%)	15( $\Omega$ ) max.	5	100	1.5( $\Omega$ ) max
$\hat{U}$ VC14CH500U	50( $\Omega$ ) $\pm$ 25(%)	15( $\Omega$ ) max.	5	100	2.5( $\Omega$ ) max
$\hat{U}$ VC14CH900U	90( $\Omega$ ) $\pm$ 20(%)	17( $\Omega$ ) max.	5	100	3.0( $\Omega$ ) max

Impedance measurement equipment: HP4291A or Corresponding equipment

Impedance measurement circuit:

\*1

\*2

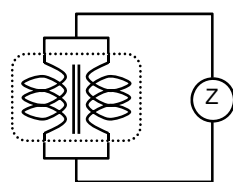

Common Mode

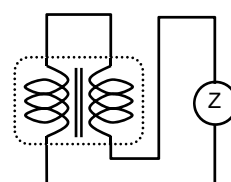

Differential Mode

7. Category Temperature Range

-40 to +85  $^{\circ}$ C

**8. Performance Characteristics**

Standard test condition

- Temperature: 15 to 35 °C
- Relative humidity: 25 to 85 %
- Atmospheric pressure: 86 to 106 kPa

When there are questions concerning measurement result

- Temperature: 20±2 °C
- Relative humidity: 60 to 70 %
- Atmospheric pressure: 86 to 106 kPa

**8-1. Mechanical Characteristics**

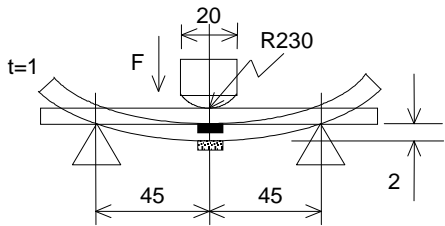
Item	Test Method	Specification
Solderability	Preheating temperature: 150 °C Preheating time: 1 min Solder temperature: 230±5 °C Duration: 4±0.5 s Immersion speed: 25 mm/s	At least 90 % of each termination is covered with the new solder.
Resistance to Soldering Heat	Preheating temperature: 150 °C Preheating time: 1 min Solder temperature: 260±5 °C Duration: 10±0.5 s Immersion speed: 25 mm/s Recovery: 48±4 hours of recovery under the standard condition after the test.	Impedance variation: within ±30 % Remaining terminal: 70 % min.
Bending Strength	Warp: 2 mm Testing board: Glass-epoxy Thickness: 1.0 mm  	No abnormality of appearance Impedance variation: within ±30 %
Vibration	Directions: 2 h each in X, Y, and Z directions (Total: 6 h) Frequency range: 10 to 55 to 10 Hz (Sweep rate: 1 min) Amplitude: 1.5 mm	No abnormality of appearance Impedance variation: within ±30 %

8-2. Environmental Characteristics

Item	Test Method	Specification
Heat Cycle	Conditions for 1 cycle Step 1: -40±3 °C, 30±3 min Step 2: +25±2 °C, 0 to 5 min Step 3: +85±3 °C, 30±3 min Step 4: +25±2 °C, 0 to 5 min Number of cycle: 200 cycle 1 to 2 hours of recovery under the standard condition after the test	No abnormality of appearance Impedance variation: within ±30 %
Load Life	Temperature: 85±2 °C Applied current: Rated current Duration: 500 h 1 to 2 hours of recovery under the standard condition after the test	No abnormality of appearance Impedance variation: within ±30 %
Humidity	Temperature: 60±2 °C Humidity: 90 to 95 %RH Duration: 500 h 1 to 2 hours of recovery under the standard condition after the test	No abnormality of appearance Impedance variation: within ±30 %
Humidity Load Life	Temperature: 60±2 °C Humidity: 90 to 95 %RH Applied current: Rated current Duration: 500 h 1 to 2 hours of recovery under the standard condition after the test	No abnormality of appearance Impedance variation: within ±30 %

9. Packaging Method

9-1. Embossed Carrier Tape

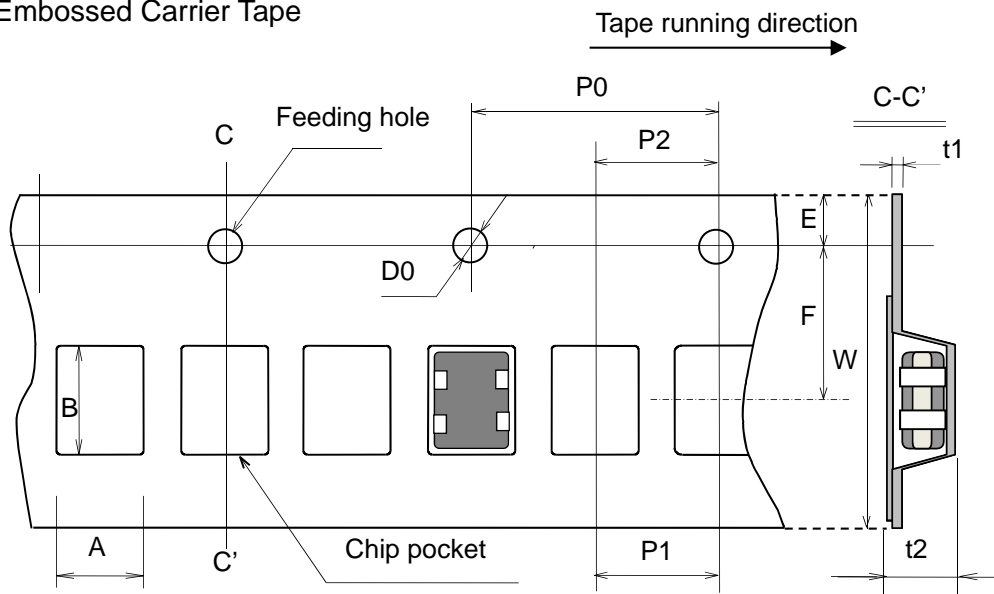

Unit: mm (inch)

A	B	W	F	E	P1
0.75±0.1 (.03±.004)	0.95±0.1 (.04±.004)	8.0±0.2 (.32±.008)	3.5±0.05 (.14±.002)	1.75±0.1 (.07±.004)	2.0±0.1 (.08±.004)
P2	P0	D0	t1	t2	
2.0±0.1 (.08±.004)	4.0±0.1 (.16±.004)	1.5+0.1,-0 (.06+.004,-0)	0.25±0.05 (.01±.002)	0.85±0.15 (.033±.006)	

9-2. Reel

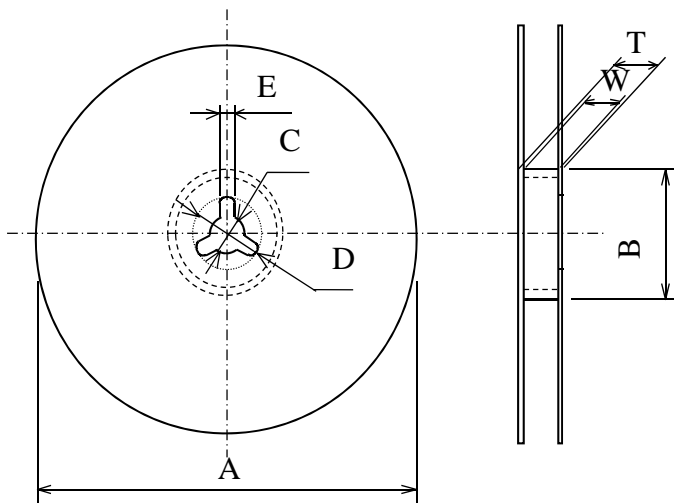

Unit: mm (inch)

A	B	C	D	E	W	T
180.0+0/-3 (7.1+0/-12)	60.0+1/-0 (2.4+.04/-0)	13.0±0.2 (.51±.008)	21.0±0.8 (.83±.03)	2.0±0.5 (.08±.02)	9.0±0.3 (.35±.01)	11.4±1.0 (.45±.04)

9-3. Taping Method

The first end (leader part) and the last end (trailer part) of each tape shall be left empty without loading the product, with the top of the leader part comprising only cover tape. (See the figure below.) The cover tape may not be sealed in the leader part and the trailer part.

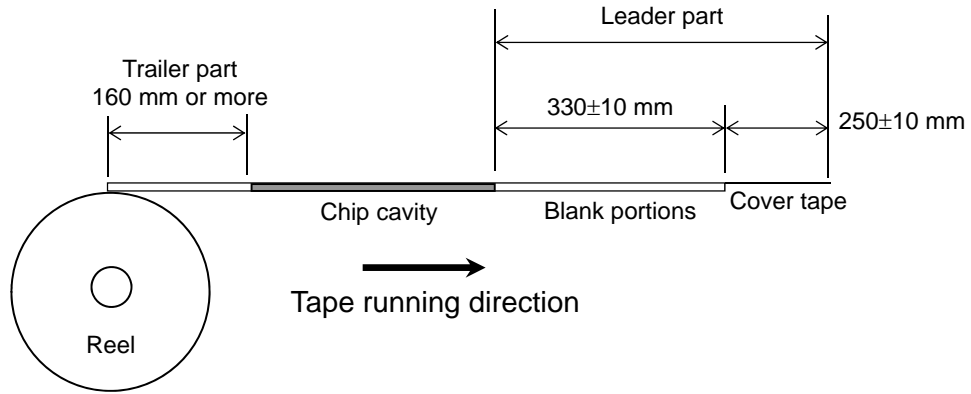

9-4. Peeling Strength of Cover Tape

0.1 to 0.7 N

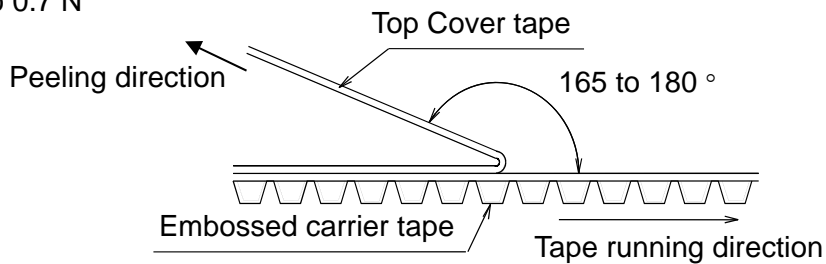

9-5. Label Indication

A label indicating the following in English shall be put on each reel and box.

- 1) Part Name
- 2) Part No.
- 3) Quantity
- 4) Lot No.

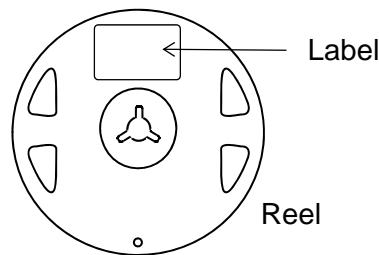

9-6. Package Quantity

Quantity per reel: 10,000 pcs.

## 10. Chip-mounting Considerations

### 10-1. Recommended Land Pattern (Only for Reflow Soldering)

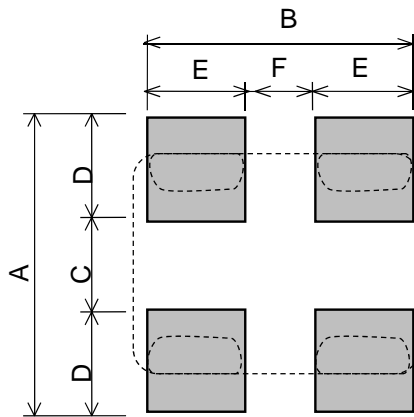

A	0.80 to 1.00 (0.031 to 0.039)
B	0.80 (0.031)
C	0.30 (0.012)
D	0.25 to 0.35 (0.010 to 0.014)
E	0.30 (0.012)
F	0.20 (0.008)

Unit: mm (inch)

- 1) When this products are mounted on a PCB, the amount of solder used (size of fillet) can directly affect this product performance.
- 2) The amount of solder applied can affect the ability of products to withstand mechanical stresses which may lead to breaking or cracking.

Therefore, when designing land-patterns it is necessary to consider the appropriate size and configuration of the solder pads which in turn determines the amount of solder necessary to form the fillets.

### 10-2. Pattern Configurations

- 1) After this products have been mounted on the PC boards, products can be subjected to mechanical stresses in subsequent manufacturing processes. For this reason, planning pattern configurations and the position of SMD inductors should be carefully performed to minimize stress.
- 2) Board separation should not be done manually, but by using the appropriate devices.

### 10-3. Considerations for Automatic Chip-Mounting

Excessive impact load should not be imposed on the inductors when mounting onto the PC boards.

10-4. Reflow Soldering

< Recommended Temperature Profile in Reflow Soldering >

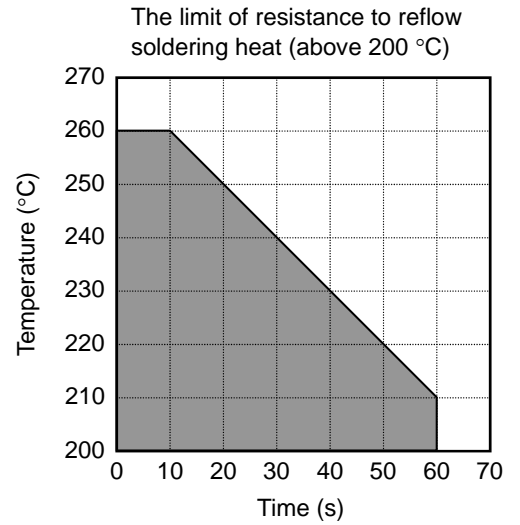
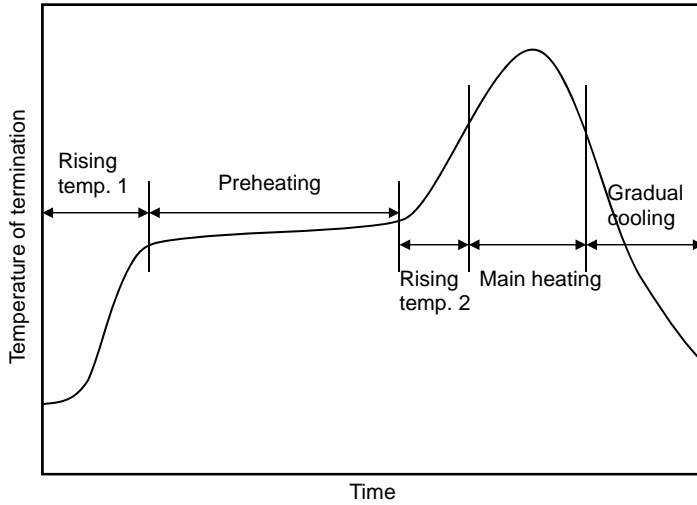

Solder	Rising temp. 1	Preheating	Rising temp. 2	Main heating	Gradual cooling
SnPb eutectic (Sn-37Pb)	The normal to Preheating temp.	140 to 160 °C	Preheating to 200 °C	235±10 °C	200 to 100 °C
	30 to 60 s	60 to 120 s	20 to 40 s	Peak	1 to 4 °C/s
SnAgCu lead-free (Sn-3Ag-0.5Cu)	The normal to Preheating temp.	150 to 170 °C	Preheating to 210 °C	250 <sup>+10</sup> <sub>-5</sub> °C	210 to 100 °C
	30 to 60 s	60 to 120 s	20 to 40 s	Peak	1 to 4 °C/s

- 1) Reflow soldering shall be within twice.
- 2) Please inquire of us when you use the different conditions.
- 3) The temperature may be changed according to the size of the board and the mounting density, etc. Please measure the temperature of termination in each type of the board before actual use.

10-5. Repair with Hand Soldering

- 1) Allow enough preheating with a blast of hot air or similar method. Use a soldering iron with the tip temperature 350 °C or less. Solder for 3 seconds or less for each termination.
- 2) Never touch this product with a tip of the solder iron.



Classification	Specification		No. 151-UV-14CH208S
Product Name	Common Mode Noise Filter (Type UV14CH)		Page 9 of 12
<p>11. Notice for use</p> <ol style="list-style-type: none"> <li>1. This specification shows the quality and performance of a unit component. Before adoption, be sure to evaluate and verify the product mounting it in your product.</li> <li>2. Precautions on the use of this products. <ol style="list-style-type: none"> <li>1) Do not apply current in excess of the rated value because this product may be high temperature.</li> <li>2) Always wear static control bands to protect against ESD.</li> <li>3) Keep this products away from all magnets and magnetic object.</li> </ol> </li> <li>3. In traffic transportation equipment (trains, cars, traffic signal equipment, etc.), medical equipment, aerospace equipment, electric heating appliances, combustion and gas equipment, disaster and crime preventive equipment, etc. in cases where it is forecast that the failure of this product gives serious damage to the human life and others, use fail-safe design and ensure safety by studying the following items. <ol style="list-style-type: none"> <li>1) Ensure safety as the system by setting protective circuit and protective equipment.</li> <li>2) Ensure safety as the system by setting such redundant circuit as do not cause danger by a signal failure.</li> </ol> </li> <li>4. The products are intended for use in general standard applications for general electronic equipment (AV products, household electric appliances, office equipment, information and communication equipment, etc.); hence, they do not take the use under the following special environments into consideration. Accordingly, the use in the following special environments, and such environmental conditions may affect the performance of the products; prior to use, verify the performance, reliability, etc. thoroughly. <ol style="list-style-type: none"> <li>1) Use in liquids such as water, oil, chemical, and organic solvent</li> <li>2) Where the product is close to a heating component, and where an inflammable such as a polyvinyl chloride wire is arranged close to the product.</li> <li>3) Use in environment with large static electricity and strong electromagnetic waves</li> <li>4) Where water or water-soluble detergent is used in cleaning free soldering or in flux cleaning after soldering(Pay particular attention to soluble flux)</li> <li>5) Storage in places outside the temperature range of -5 to 40 °C and humidity range of 40 to 60 %RH</li> <li>6) Use or storage in places exposed to open-air, dusty atmosphere, and direct sunlight</li> <li>7) Use or storage in places full of corrosive gases such as sea breeze, Cl<sub>2</sub>, H<sub>2</sub>S, NH<sub>3</sub>, SO<sub>2</sub>, and No<sub>x</sub></li> <li>8) Use or storage in such a place where the product is wetted due to dew condensation</li> <li>9) Where the product is sealed or coated with resin, etc.</li> <li>10) Storage over a year after our delivery (This item also applies to the case where the storage method specified in item 5) to 8) has been followed.)</li> </ol> </li> <li>5. In case that there are any doubt about safety problems, please inform us early and be sure to evaluate and verify the product mounting it in your product before adoption.</li> </ol>			
Constitution Jun. 29, 2017	UV [ ] Corporation		

Classification <p style="text-align: center;"><b>Specification</b></p>	No. 151-UV-14CH208S
Product Name <p style="text-align: center;"><b>Common Mode Noise Filter (Type UV14CH)</b></p>	Page 10 of 12
<p>12. Regulation</p> <ol style="list-style-type: none"> <li>1) This product has not been manufactured with any ozone depleting chemical controlled under the Montreal Protocol .</li> <li>2) All materials used in this product are existing chemical substances recognized under " laws on examination of chemical substances and regulations of manufacturing and others."</li> <li>3) Please contact us to obtain a notice as to whether this product has passed inspection under review criteria primarily based on Foreign Exchange and Foreign Trade Control law and appended table in the Export Control law.</li> <li>4) This product complies with the RoHS Directive (Restriction of the use of certain Hazardous Substances in electrical and electronic equipment (DIRECTIVE 2011/65/EU)).</li> </ol> <p>13. Production Site</p> <p style="padding-left: 40px;">Device Solutions Business Division, Panasonic Corporation (JAPAN)</p>	
Constitution Jun. 29, 2017	UV [ } Corporation

**Impedance Characteristics <Reference Data>**

●  $\hat{U}$ VC14CH120

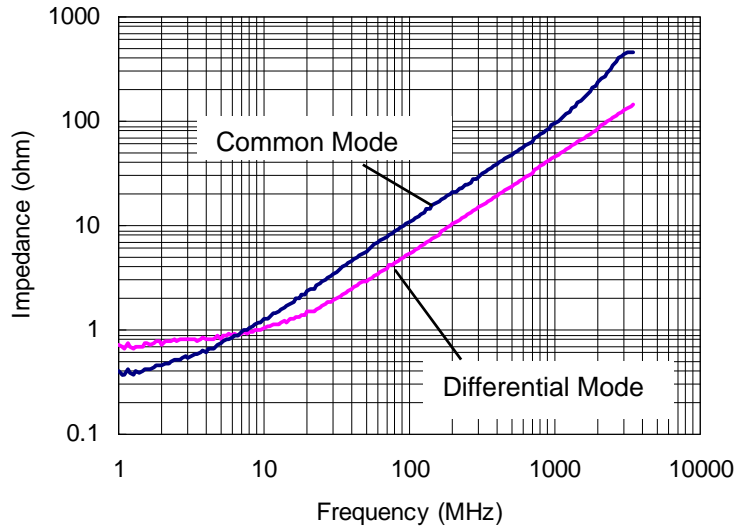

●  $\hat{U}$ VC14CH350

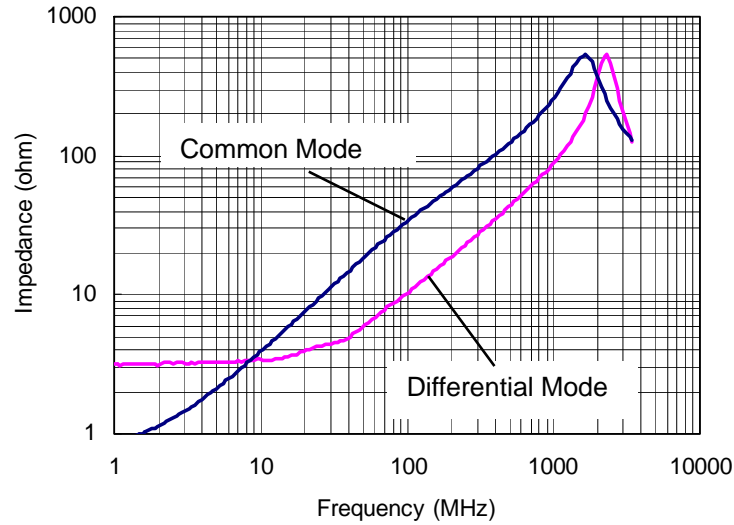

●  $\hat{U}$ VC14CH500

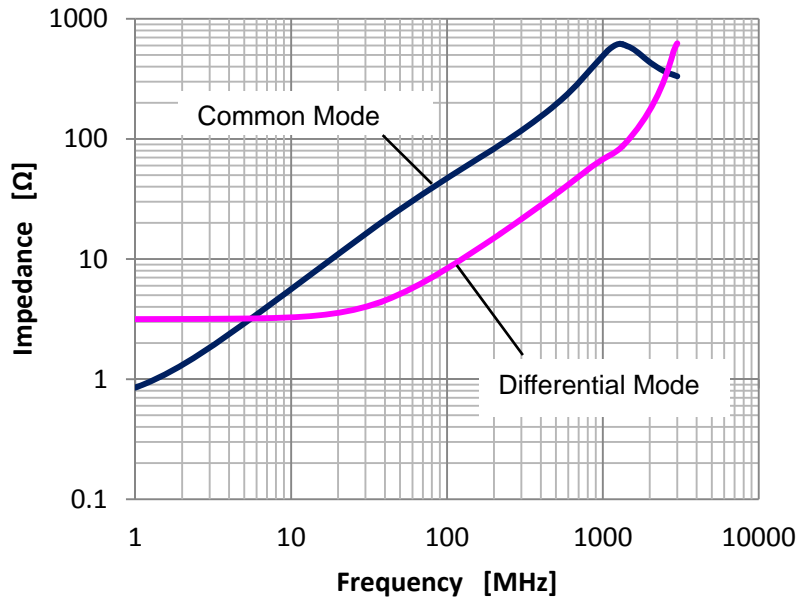

●  $\hat{U}$ VC14CH900

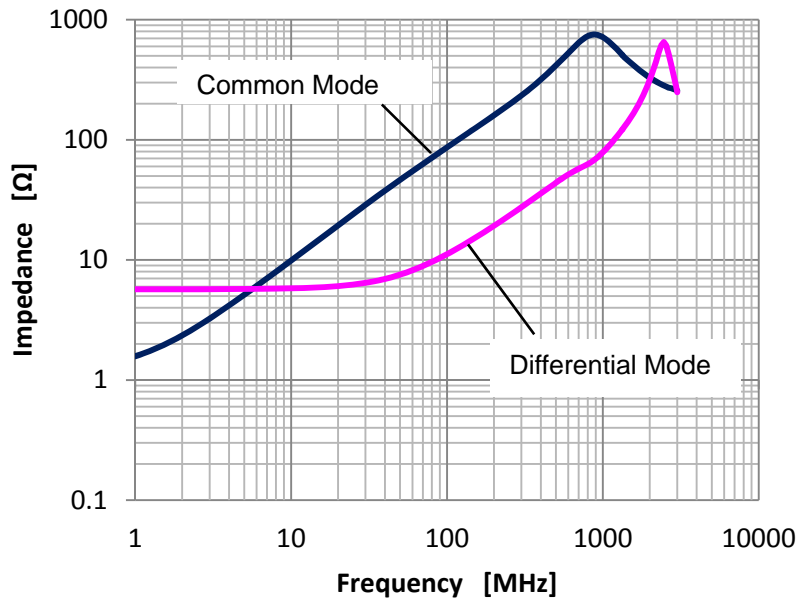

Common Mode

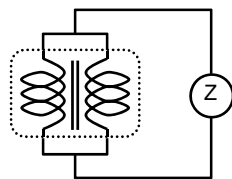

Differential Mode

