



快特電子股份有限公司

Quictron Corporation

115 台北市區南港區成功路一段32號4樓之10

Rm. 10, 4F., No.32, Sec. 1, Chenggong Rd., Nangang Dist., Taipei City 115, Taiwan, R.O.C

Tel : +886-2-2788-6849 Fax : +886-2-2788-7949

APPROVAL SHEET

Customer 客 戶	
Description 零 件 概 述	24PIN, 2.5G BASE-T LAN Transformer, KM24SG081 G
Customer's Part No. 客 戶 料 號	
Vendor's Part No. 供 應 商 料 號	KM24SG081 G

SUPPLIED BY	APPROVED BY
蔣利敏	黃永華 Johnny Huang

A. MECHANICAL(unit:mm)

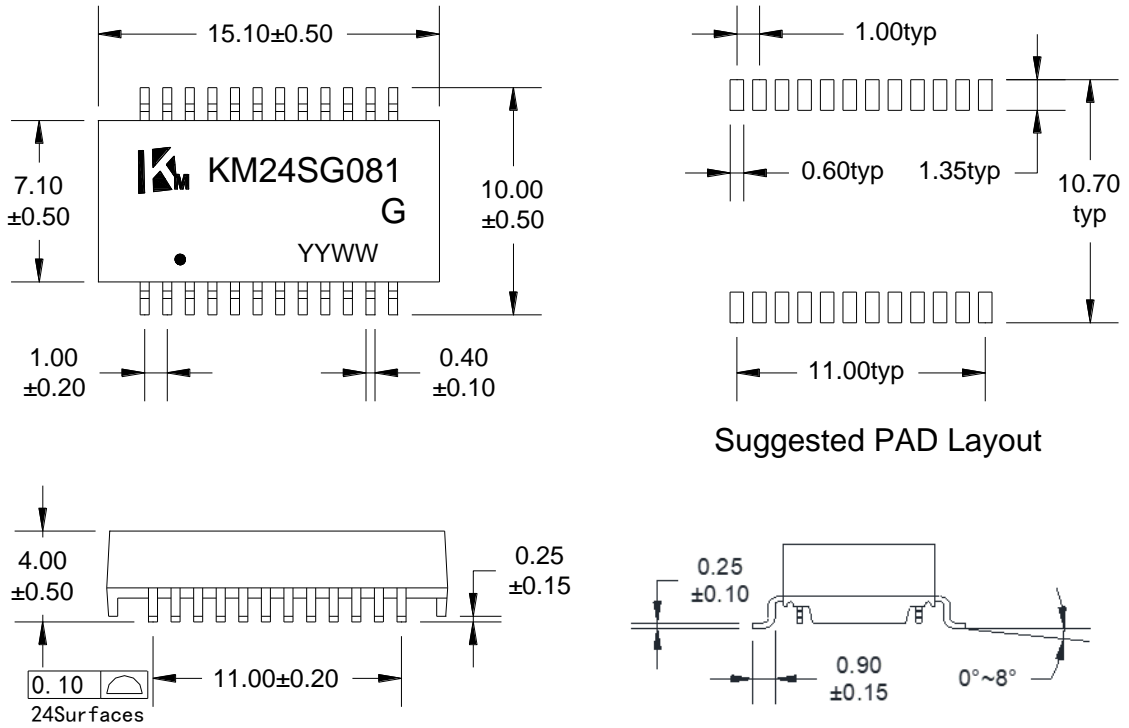

B. SCHEMATICS

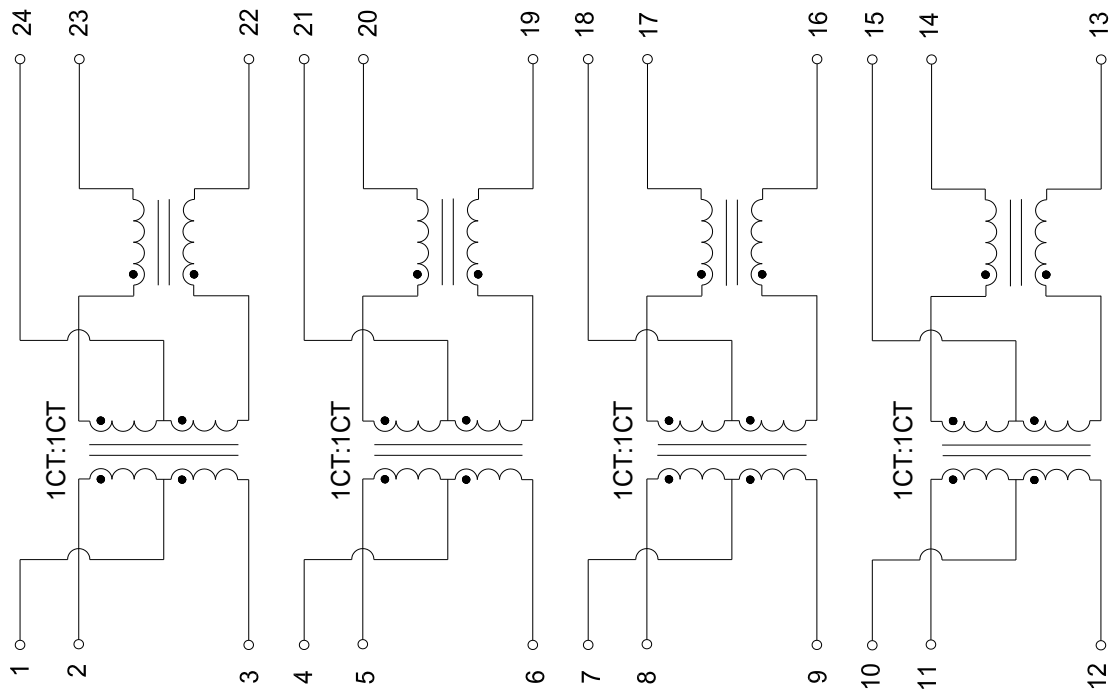

DESCRIPTION	KM P/N	SPEC NO.	REV: R0
2.5G BASE-T	KM24SG081 G		PAGE: 1/3

C. ELECTRICAL SPECIFICATIONS @25 °C

1. OCL: 160uH Min @ 100 KHz, 0.1V , 8mA DC Bias
2. Leakage Inductance: 0.5uH Max @ 100KHz, 0.1V
3. DCR: 1.0Ω Max
4. Turns Ratio: 1CT:1CT ±5%
5. Insertion Loss: -0.5 dB Max @ 1-50 MHz
-1.0 dB Max @ 50-125 MHz
6. Return Loss: -20 dB Min @ $1 \leq f \leq 40$ MHz
-15 dB Min @ $40 < f \leq 125$ MHz
7. Cross Talk: -30 dB Min @ 1-150MHz
8. Common Mode Rejection: -30 dB Min @ 1-150 MHz
9. Isolation Hipot: 1500VAC 1mA 60s
10. Operating temperature 0 °C to +70 °C
11. Storage temperature -25 °C to +125 °C

DESCRIPTION	KM P/N	SPEC NO.	REV: R0
2.5G BASE-T	KM24SG081 G		PAGE: 2/3

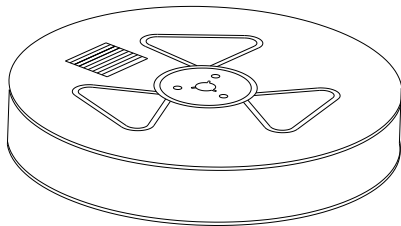
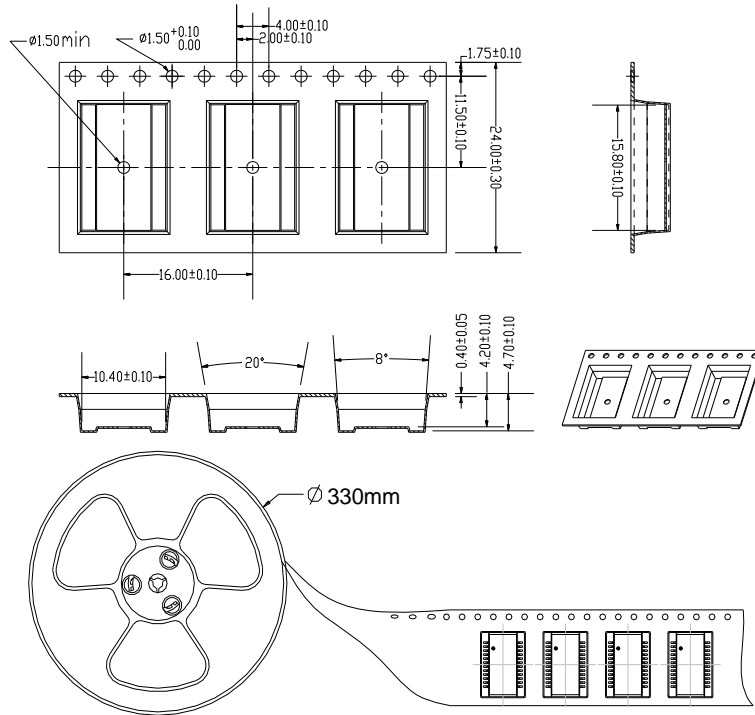
D. PACKAGE INFORMATION

three reel

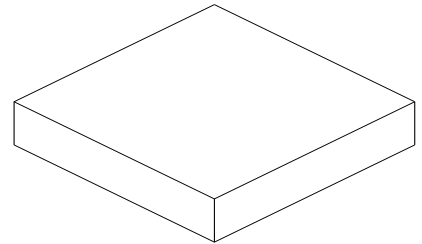

Inner Carton

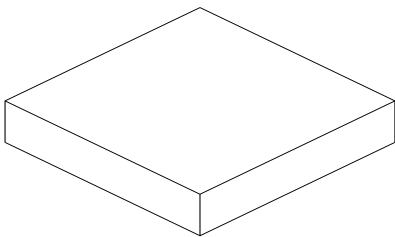

two Inner Carton

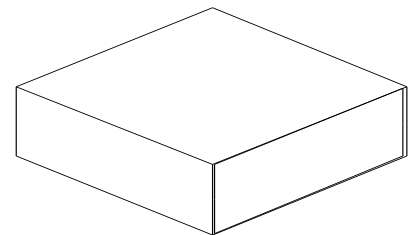

Export Carton

Package Quantity:

One Reel=800Pcs

One Inner Carton=800*3=2400Pcs

One Export Carton=2400*2=4800Pcs

DESCRIPTION	KM P/N	SPEC NO.	REV: R0
2.5G BASE-T	KM24SG081 G		PAGE: 3/3