

APPROVED SHEET

CUSTOMER: 快特

KM P/N: KM24SM706 G

JWD P/N: SM24706 G

REV: R0

DESCRIPTION: 10G BASE-T

CUSTOMER APPROVAL		COMPANY APPROVAL	
INSPECTED BY:		ISSUED BY:	Sea
CHECKED BY:		CHECKED BY:	
APPROVED BY:		APPROVED BY:	
APPROVED DATE:		ISSUED DATE:	2018-11-9

Please Return One Copy to Us After Approved,TKS! (承认后请回寄一份,谢谢)



A. MECHANICAL(unit:mm)

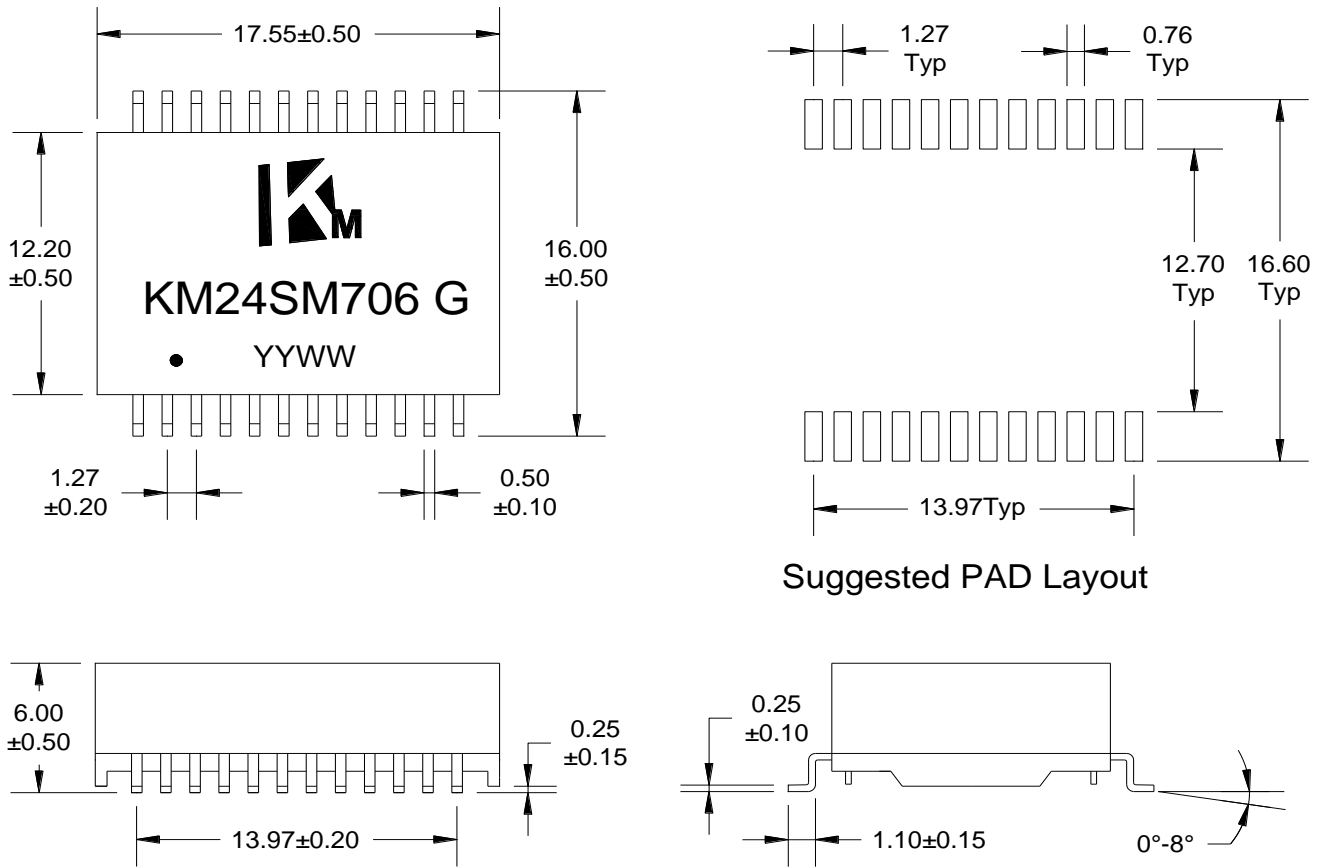

B. SCHEMATICS

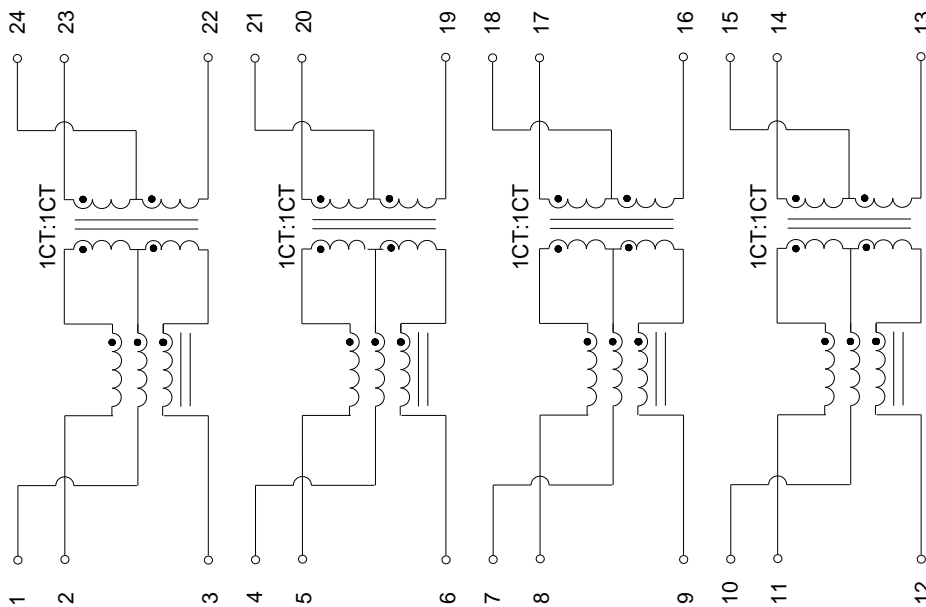

DESCRIPTION	KM P/N	SPEC NO.	REV: R0
10G BASE-T	KM24SM706 G		PAGE: 1/3



C. ELECTRICAL SPECIFICATIONS @25°C

1. OCL: 120 uH Min @100KHz 100mV
2. Leakage Inductance: 0.5uH Max @ 100KHz, 0.1V
3. DCR: 900mΩ Max
4. Turns Ratio: 1CT:1CT±5%
5. Insertion Loss: -1.2dB max @ 1~200 MHz
-1.5dB max @ 200~300 MHz
-2.0dB max @ 300~400 MHz
-3.0dB max @ 400~500 MHz
6. Return Loss: -18 dB Min @ 1~100 MHz
-16 dB Min @ 100~200 MHz
-12 dB Min @ 200~300 MHz
-10 dB Min @ 300~400 MHz
-8 dB Min @ 400~500 MHz
7. Cross Talk: -25 dB Typ @ 1-500 MHz
8. Common Mode Rejection: -25 dB Typ @ 1-500 MHz
9. Isolation Hipot: 1500VAC 1mA 60S
10. Operating temperature 0°C to +70°C
11. Storage temperature -20°C to +125°C

DESCRIPTION	KM P/N	SPEC NO.	REV: R0
10G BASE-T	KM24SM706 G		PAGE: 2/3



D. PACKAGE INFORMATION

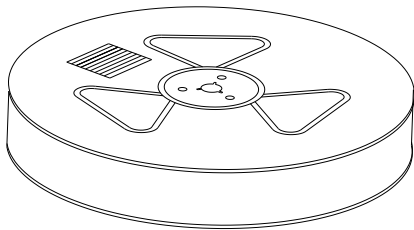
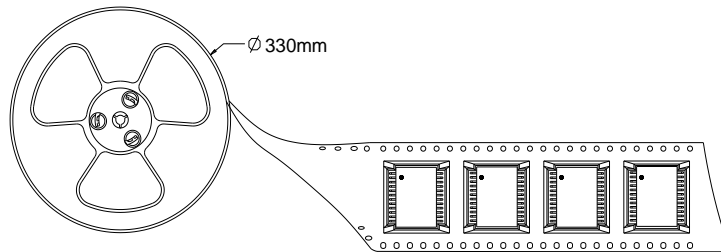
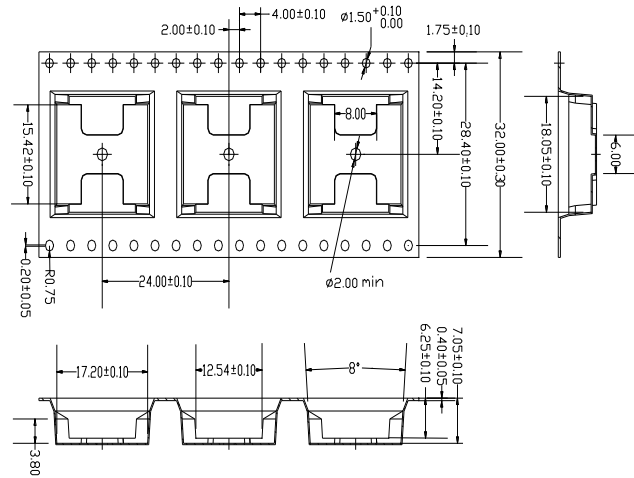

two reel

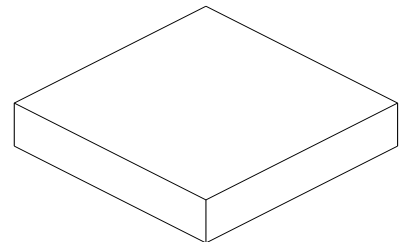

Inner Carton

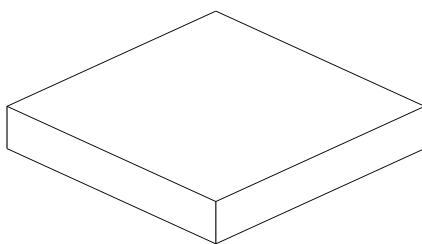

five Inner Carton

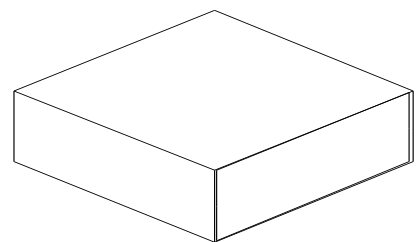

Export Carton

Package Quantity:

One Reel=350Pcs

One Inner Carton=350*2=700Pcs

One Export Carton=700*5=3500Pcs

DESCRIPTION	KM P/N	SPEC NO.	REV: R0
10G BASE-T	KM24SM706 G		PAGE: 3/3